

Patented product
 专利产品

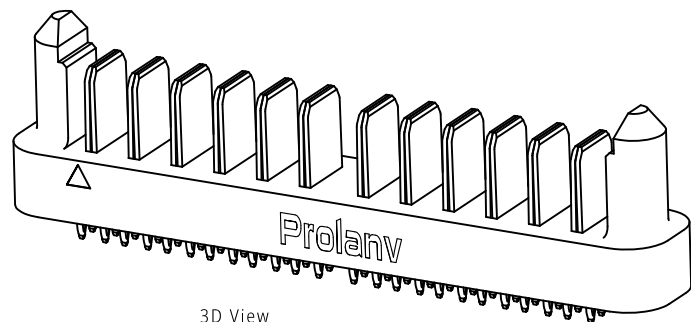

3D View

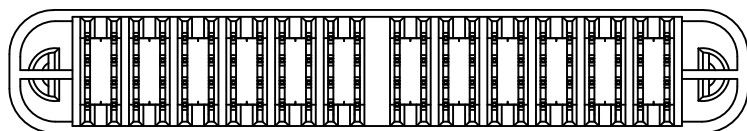
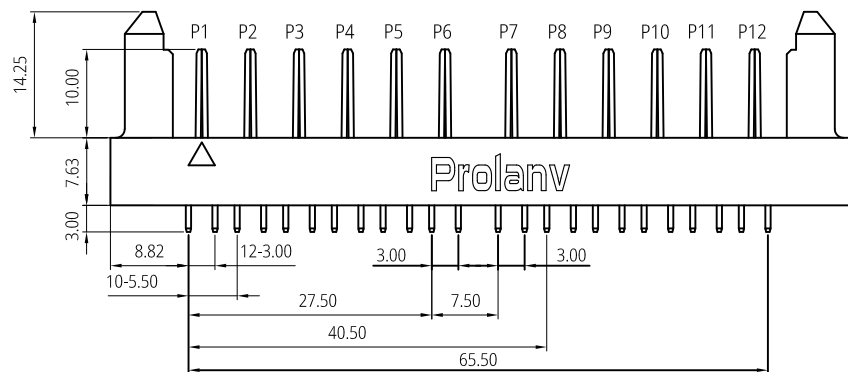
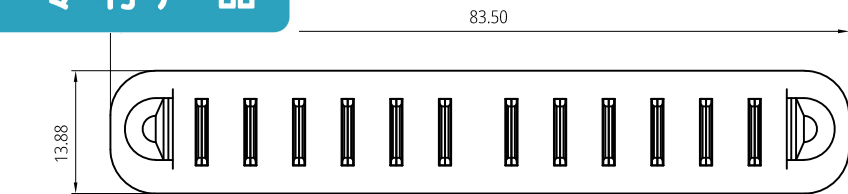
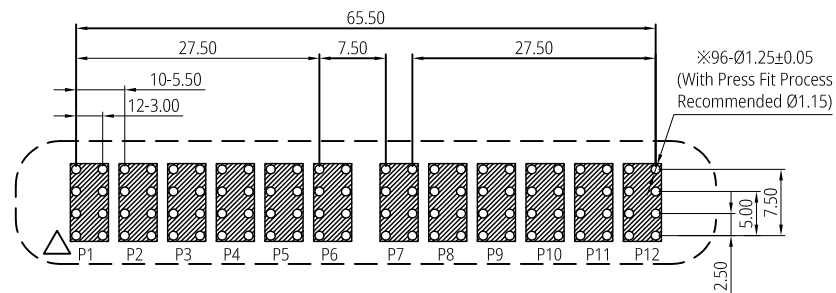
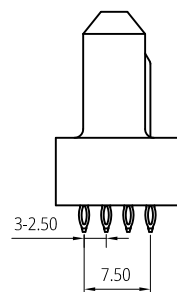

Recommended P.C.B layout (Top View)
 Tolerance ± 0.05

Notes:

- Material Specification
 - Housing: High Temperature Thermoplastic. UL94 V-0, Black.
 - Contact: High Conductivity Copper Alloy.
- Plating Specification:
 - Contact: Au $30\mu\text{m}$ plating on Contact area, matte Tin $80\mu\text{m}$ min. on Tails and $50\mu\text{m}$ min. Nickel overall.
- Electrical performance
 - Voltage Rating: 250v DC/Power Pin, 120v DC/Signal Pin.
 - Current Rating: 60A/per Power Blade, 3A/Signal Pin.
 - LLCR: initial $0.6\text{m}\Omega$ max., finished $1.0\text{m}\Omega$ max.(per Power Blade) initial $10\text{m}\Omega$ max., finished $20\text{m}\Omega$ max.(per Signal Pin)
 - Dielectric Withstanding Voltage: 1500v DC rms/Power Blade; 500v DC rms/Signal Pin,
 - Insulation Resistance: 5000 M Ω min/power blade; 500 M Ω min/signal pin;
- Mechanical Performance:
 - Insertion force: 245N (25.0 kgf) (max.)
 - Withdrawal force: 9.8N~147N (1.0~15.0 kgf).
 - Durability life: 10,000 cycles (max.)
- IR Reflow: The peak temperature on board shall be maintained for 10 seconds at $260\pm 5^\circ\text{C}$.
- Operating Temperature Range: $-40\sim 125^\circ\text{C}$ (without loss function).
- All parts RoHS and Reach compliant.
- ※ See SPS-PDC-06 for Terminal details.

THIS DRAWING AND SPECIFICATION ARE THE PROPERTY OF Prolanv AND SHALL NOT BE COPIED OR USED WITHOUT Prolanv PERMISSION

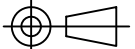
GENERAL TOLERANCES UNLESS SPECIFIED		PART NO. PDC2910F0001	Prolanv [®]			
X \pm 0.30	X $^\circ$ \pm 3 $^\circ$					
XX \pm 0.20	.X $^\circ$ \pm 2 $^\circ$	APPROVED BY Kysin	TITLE EN60A series Power Male. 12Pairs Pin, Vertical DIP Type			
XXX \pm 0.05	.XX $^\circ$ \pm 1 $^\circ$	CHECKED BY Harry	DWG NO. PDC29-10			
SIZE A4	UNITS mm[only]	DRAWN BY Lucie		SHEET 1 / 2	SCALE 1:1	REV B0

1 2 3 4 5 6 7 8

F

F

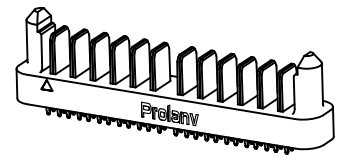

15Pcs/Tray

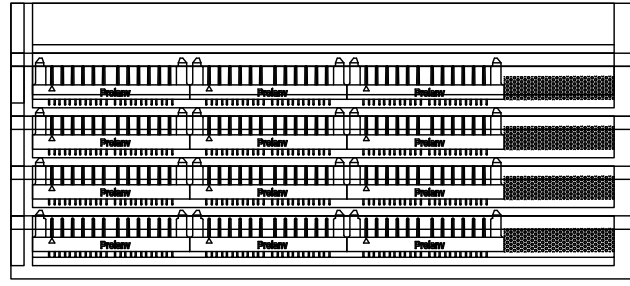

Total: 2x4 Layers

E

E

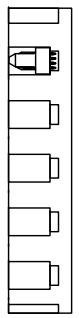
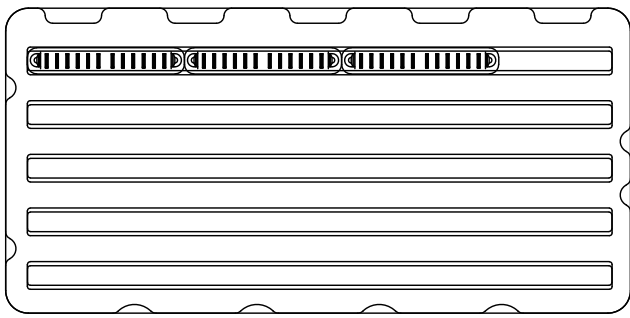

D

D

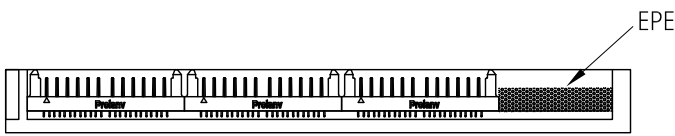

EPE

C

C

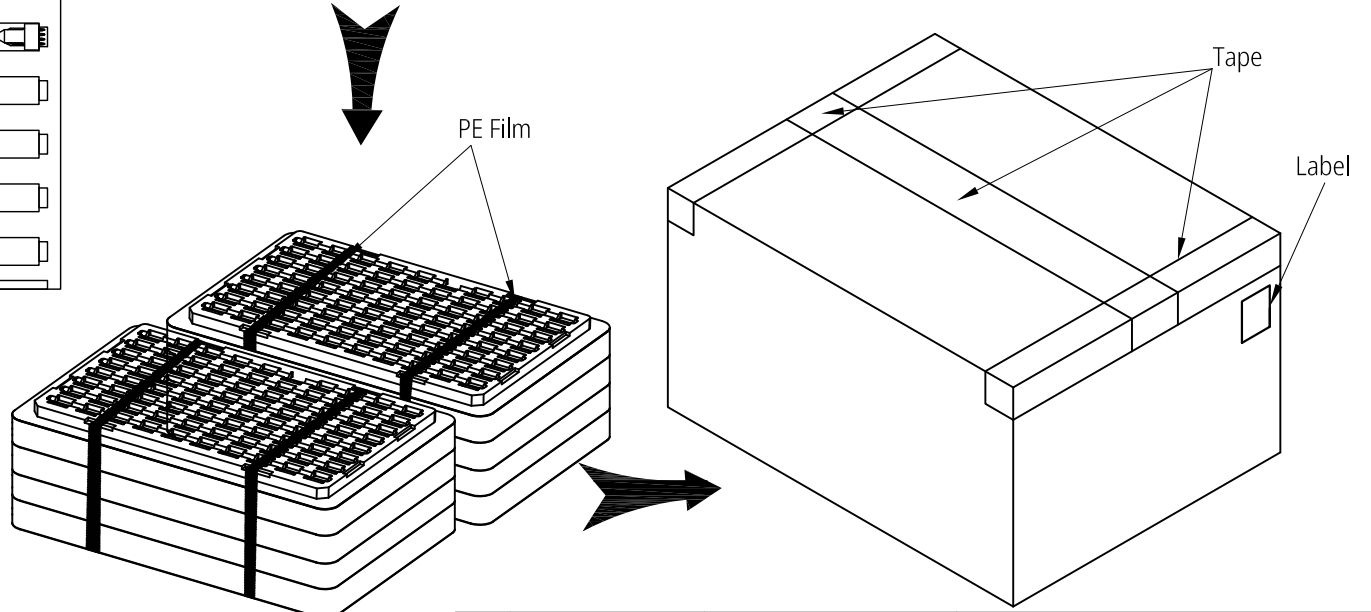

PE Film

Tape

Label

B

B

Notes:

1. Q'ty: 15 Pcs/Tray, 2x4 Layers=120 Pcs/Carton.
2. Tray Pallet size: 332*162mm.
3. Carton size: 350*350*155mm.

A

A

THIS DRAWING AND SPECIFICATION ARE THE PROPERTY OF Prolanv AND SHALL BE COPIED OR USED WITHOUT Prolanv PERMISSION

GENERAL TOLERANCES UNLESS SPECIFIED		PART NO.	
X ± 0.30	X° ± 3°	PDC2910F0001	
XX ± 0.20	XX° ± 2°	APPROVED BY	
XXX ± 0.05	XXX° ± 1°	Kysin	
CUSTOMER DRAWING		CHECKED BY	
		Harry	
SIZE	UNITS	DRAWN BY	
A4	mm[only]	Lucie	

TITLE		
EN60A series Power Male. 12Pairs Pin, Vertical DIP Type Packaging		
DWG NO.		
P-PDC29-10		
SHEET		
2 / 2		
SCALE		
N/A		
REV		
A2		

Prolanv®

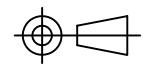

1 2 3 4 5 6 7 8